

AutoFlow™



A U T O M A T I C R E V O L V I N G D O O R



Horton Automatics' AutoFlow™ automatic revolving doors are energy efficient and offer easy, hands free operation.

SERIES 9300



Innovative Features and Economical Performance

The **AutoFlow™** automatic revolving door is designed for use in hotels, hospitals, airports, banks, office buildings and similar applications.

AutoFlow™ doors feature motion detectors at each opening that start rotation on user approach. A reduced speed feature slows door rotation to allow easy access in larger doors for wheelchairs, strollers and large parcels along with four field programmable voice prompts.

The microprocessor control provides wireless remote door speed adjustment and set up. A self-diagnostic display makes service and maintenance easy.

The solid-state voice module that alerts pedestrians is included for both reduced speed and resume speed conditions. In the event of power failure, the doors allow easy manual operation.

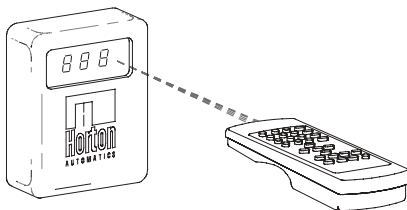

Exclusive wireless remote for setup and adjustment

Horton has the largest factory trained and certified distribution force to install, service and maintain your doors anywhere in the world.

Standard Features:

- ▶ Standard diameters from 8' to 12'
- ▶ Round or Segmented™ drum design
- ▶ Curved tempered or laminated wall glass
- ▶ Bookfold collapsing hardware
- ▶ Flexible design
- ▶ Quick delivery on standard finishes
- ▶ Safety edges
- ▶ Bump-To-Idle™ safety
- ▶ Activating sensors
- ▶ Medium stile

Specifier Options:

- ▶ Finishes (Anodized aluminum, paint, metal clad, wood)
- ▶ Special diameters and heights
- ▶ Aluminum roof panels
- ▶ Ceiling lights
- ▶ Glass ceiling
- ▶ Safety features VistaStop™ and FootGuard™
- ▶ AutoLock™ - automatic after-hours locking
- ▶ Magnetic breakaway for high wind conditions
- ▶ EntryGuard™ - late entry protection



AutoFlow™

revolving doors are available with a variety of standard and optional features and diameters. Horton doors easily accommodate a full array of design, traffic and installation needs.

Segmented™ Drum

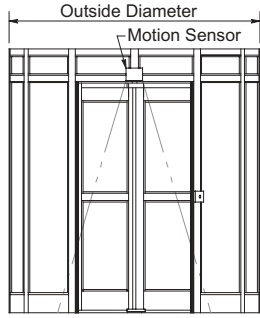

Elevation & Floor Plan

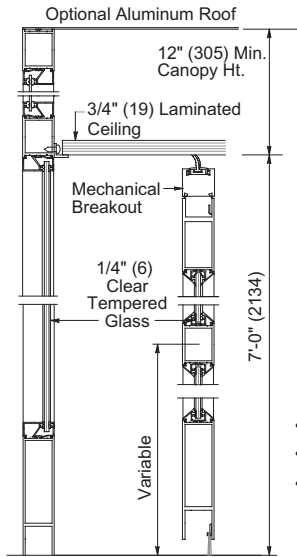

Vertical Section

Standard Segmented™ Drum Dimensions

Inside Diameter	Entry - 3 Wing	Entry - 4 Wing
8'-0" (2438)	3'-4 3/4" (1035)	5'-3 15/16" (1624)
9'-0" (2743)	3'-10 3/4" (1187)	6'-3/4" (1848)
10'-0" (3050)	4'-4 3/4" (1340)	6'-9 1/24" (2070)
12'-0" (3658)	4'-4 3/4" (1340)	8'-3" (2515)

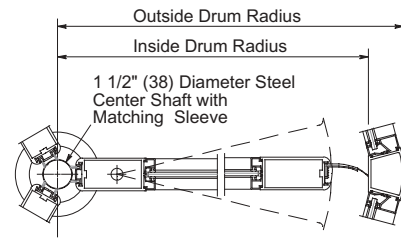

- Breakaway available with optional magnetic lock.
- Mini Grands (12' 0" Dia.) have full safety.
- Optional Round Canopy on Segmented™ drum enclosure.

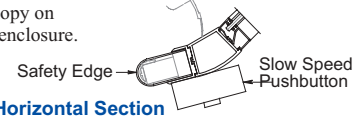

Horizontal Section

Round Drum

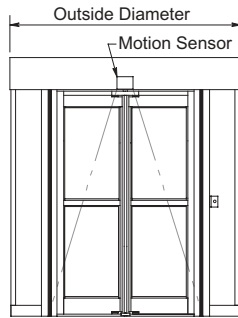

Elevation & Floor Plan

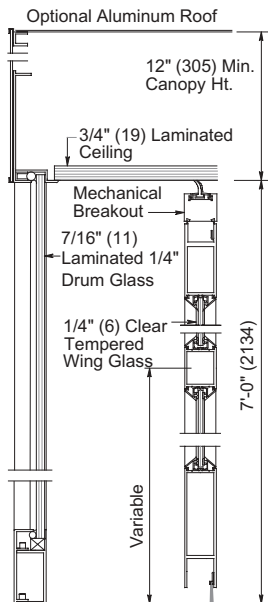

Vertical Section

Standard Round Drum Dimensions

Inside Diameter	Entry - 3 Wing	Entry - 4 Wing
8'-0" (2438)	3'-7 3/8" (1102)	5'-4 5/16" (1633)
9'-0" (2743)	4'-1 3/8" (1254)	6'-0 13/16" (1849)
10'-0" (3050)	4'-7 3/8" (1406)	6'-9 5/16" (2065)
12'-0" (3658)	5'-7 3/8" (1711)	8'-2 1/4" (2495)

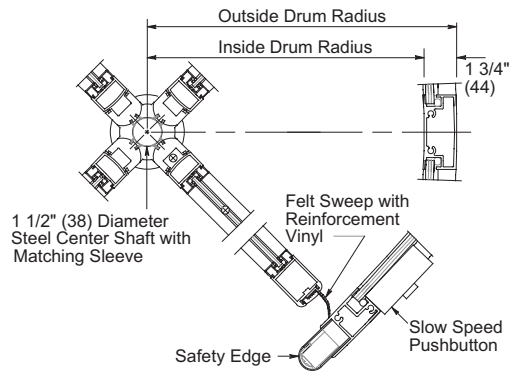

- Breakaway available with optional magnetic lock.
- 1/4 (6) Tempered Glass available for Drum and up to 1" (25) Insulated Glass available for both Wings and Drum

Horizontal Section



4242 Baldwin Boulevard
Corpus Christi,
Texas, U.S.A. 78405-3399
Tel: 800-531-3111, 361-888-5591
Fax: 800-531-3108, 361-888-6510
www.hortondoors.com

Horton Automatics, Ltd.
Unit A, Hortonwood 31
Telford, Shropshire, England TF1-7YZ
Tel: 01952 670169, Fax: 0192 670181
International Tel: ++44-1952-670169
International Fax: ++44-1952-670181



Form F502
© 2003 Horton Automatics
Printed in U.S.A.

Horton Automatics reserves the right to alter its product and specifications without notice.